

Assembly instructions
 Montageanweisung
 Instructions de montage
 Montážní návod
 Montážny návod
 Montagevejledning
 Instrucciones de montaje
 Szerelési utasítás
 Istruzioni di montaggio
 Montasje anvisning
 Montage instructie
 Instruções de montagem
 Instrukcja montażu
 Montageanvisning
 Asennusohjeet
 Montaj talimatı
 Instrucțiuni de montaj
 Инструкция по монтажу
 οδηγία συναρμολόγησης
 安装说明书
 تعليمات التركيب



Danger
 Lebensgefahr
 Danger de mort
 Nebezpečí
 Nebezpečnostvo
 Fare
 Peligro
 Életveszély
 Pericolo di morte
 Fare
 Levensgevaar
 Perigo
 Niebezpieczeństwo
 Varning
 Vaara
 Hayati Tehlike
 Pericol
 Опасность
 κίνδυνος θανάτου
 危險
 خطر على الحياة



Installation by electricians only
 Montage nur durch Elektrofachkräfte
 Montage uniquement par un électricien
 Montáž pouze osobami s elektrotechnickou kvalifikací
 Montáž iba osobami s elektrotechnickou kvalifikáciou
 Må kun installeres af en aut. el-installatør
 Debe ser instalado por un profesional eléctrico
 Csak szakképzett személy szerelheti
 Montaggio esclusivamente ad opera di personale specializzato
 Må monteres av autorisert installatør Gr.L
 Montage alleen door elektromonteurs
 Deve ser instalado por um profissional
 Montaz tylko przez uprawnionych instalatorów
 Får endast utföras av behörig elektriker
 Asennus vain sähköasentajan toimesta
 Sadece uzman kişiler monte edebilir
 Instalare numai de catre electricieni
 Монтаж может производить только электрик
 Εγκατάσταση μόνο από ηλεκτρολόγους
 仅允许合格电气技师进行安装
 التركيب فقط من قبل عمال كهرباء اخصائيين

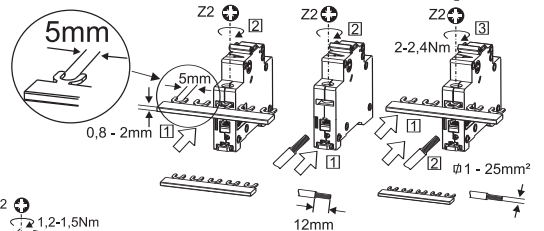
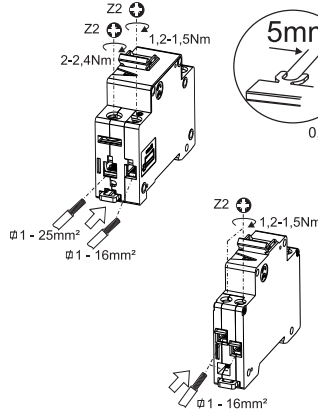
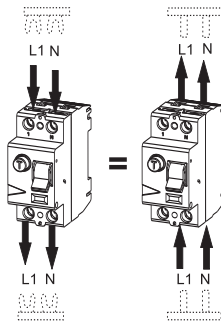
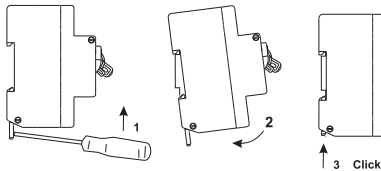
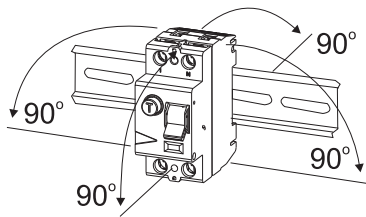

Extension for MCB's:	
Supplementary Protector Technical Data	USA/Canada UL 1077
1 phase (series-fuse 100A): 5 kA - 277 V ~ 60 Hz	Tripping Current: 155 % of rated current at 30°C
3 phase (series-fuse 100 A): 5 kA - 277/480 V ~ 60 Hz	Cu 75°C, min. AWG 18, max. AWG 4, Nm 2.4

<p>grün green vert zelený Grøn Verde zöld verde Grønn groen</p> <p>Verde zielony grön Vihreä yeşil Verde зеленый πράσινο 绿色 أخضر</p>		<p>rot red rouge červený Rød Rojo vörös rosso Rød rood</p> <p>Vermelho czerwony röd Punainen kirmizi Rosu красный оккиво 紅色 أحمر</p>	
--	--	--	--

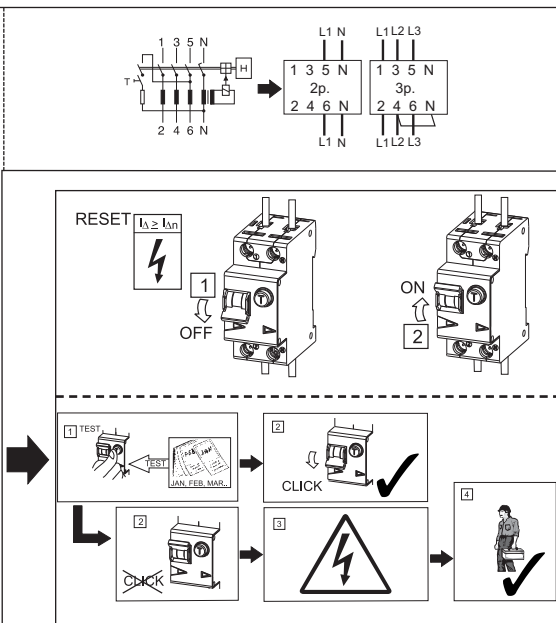
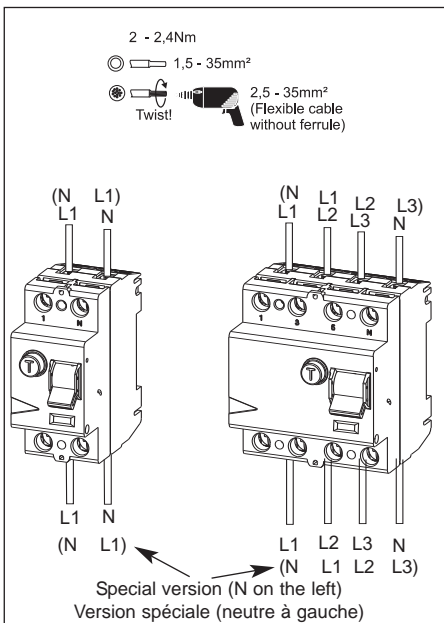

Extension for RCD's:	
Maximum back-up fuse	Short circuit
$I_n = 16-63A$	63 A gG/gL
$I_n = 80A$	80 A gG/gL
$I_n = 100A$	100 A gG/gL

Erweiterung für FI's:	
Max. zulässige Vorsicherung	Kurzschluss
$I_n = 16-63A$	63 A gG/gL
$I_n = 80A$	80 A gG/gL
$I_n = 100A$	100 A gG/gL

