

		IEC 61024-1 IEC 61312-1
		IEC 60364-5-534 IEC60364-5-53 Clause 534 VDE V 0100-534 ÜVE/ÖNORM E8001-1 UTE C 15-443
		VDE 0100 - 410 VDE 0100 - 430 ÖVE-EN1 Teil 3
		IEC 61643-1 EN 61643-1

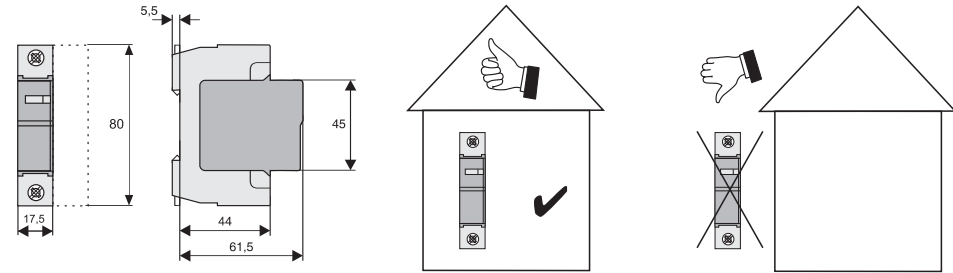
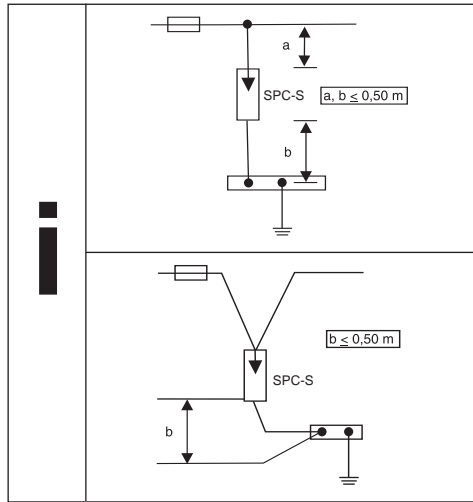

	SPC-S-15/75	-20/130	-20/175	-20/280	-20/335	-20/385	-20/460	-20/580	-N/PE
U <sub>T</sub> (IEC 61643-1)	75V	130V	175V	335V	400V	400V	580V	580V	260V
	$I \leq 50 \text{ kA}_{\text{eff}} / \leq 50 \text{ kA}_{\text{r.m.s.}}$								

## SPC-S

Assembly instructions  
Montageanweisung  
Instructions de montage  
Montážní návod  
MontážnÝ návod  
Montagevejledning  
Instrucciones de montaje  
Szerelési utasítás  
Istruzioni di montaggio  
Montasje anvisning  
Montage instructie  
Instruções de montagem  
Instrukcja montażu  
Montageanvisning  
Asennusohjeet  
Montaj talimatı  
Instrucțiunile de montaj  
Инструкция по монтажу  
οδηγία συναρμολόγησης  
安装说明书  
تعليمات التركيب



Danger  
Lebensgefahr  
Danger de mort  
Nebezpečí  
Nebezpečnost  
Fare  
Peligro  
Életveszély  
Pericolo di morte  
Fare  
Levensgevaar  
Perigo  
Niebezpieczeństwo  
Varning  
Vaara  
Hayatı Tehlike  
Pericol  
Οπικότητα  
κίνδυνος θανάτου  
危險  
خطر على الحياة



Installation by electricians only  
Montage nur durch Elektrofachkräfte  
Montage uniquement par un électricien  
Montáž pouze osobami s elektrotechnickou kvalifikací  
Montáž iba osobami s elektrotechnickou kvalifikáciou  
Må kun installeres af en aut. e-installatør  
Debe ser instalado por un profesional eléctrico  
Csak szakképzett személy szerelheti  
Montaggio esclusivamente ad opera di personale specializzato  
Må monteres av autorisert installatør Gr.L  
Montage alleen door elektromonteurs  
Deve ser instalado por um profissional  
Montaz tylko przez uprawnionych instalatorów  
Får endast utföras av behörig elektriker  
Asennus vain sähköasentajan toimesta  
Sadece uzman kişiler monte edebilir  
Instalare numai de catre electricieni  
Монтаж может производить только электрик  
Εγκατάσταση μόνο από ηλεκτρολόγους  
仅允许合格电气技师进行安装  
التركيب فقط من قبل عمال كهرباء اخصائيين

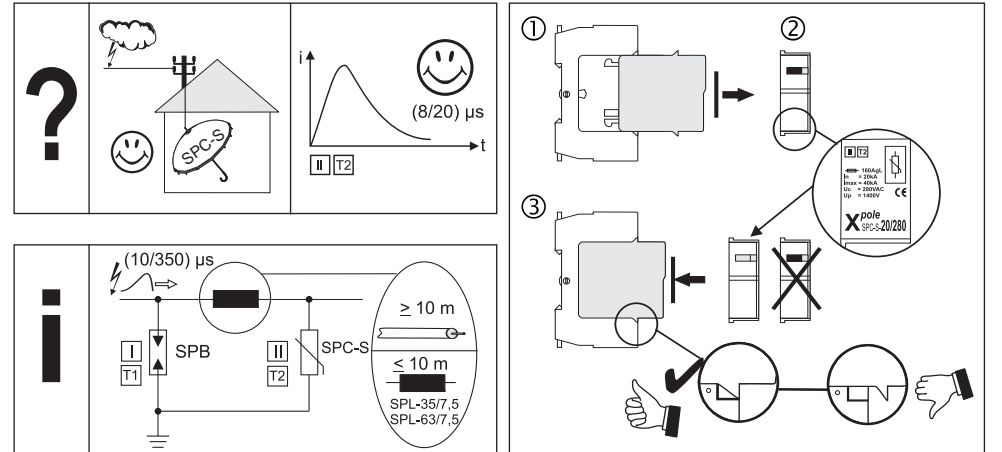
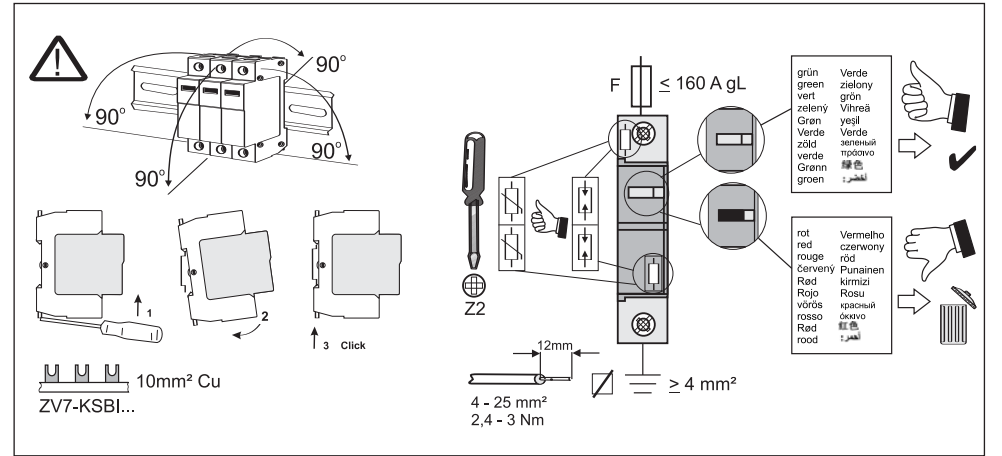

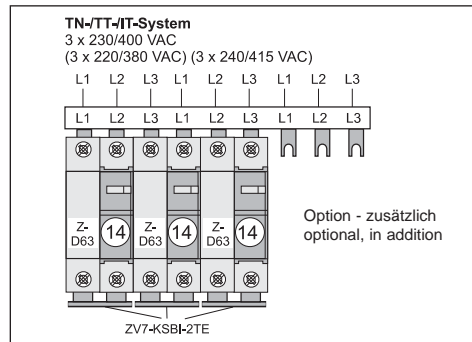
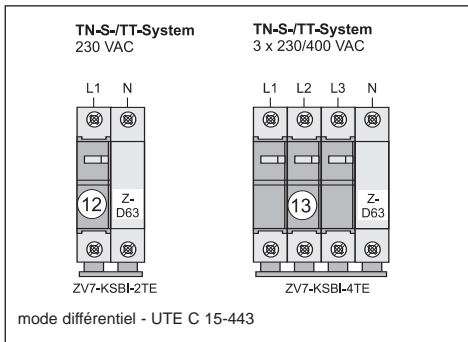
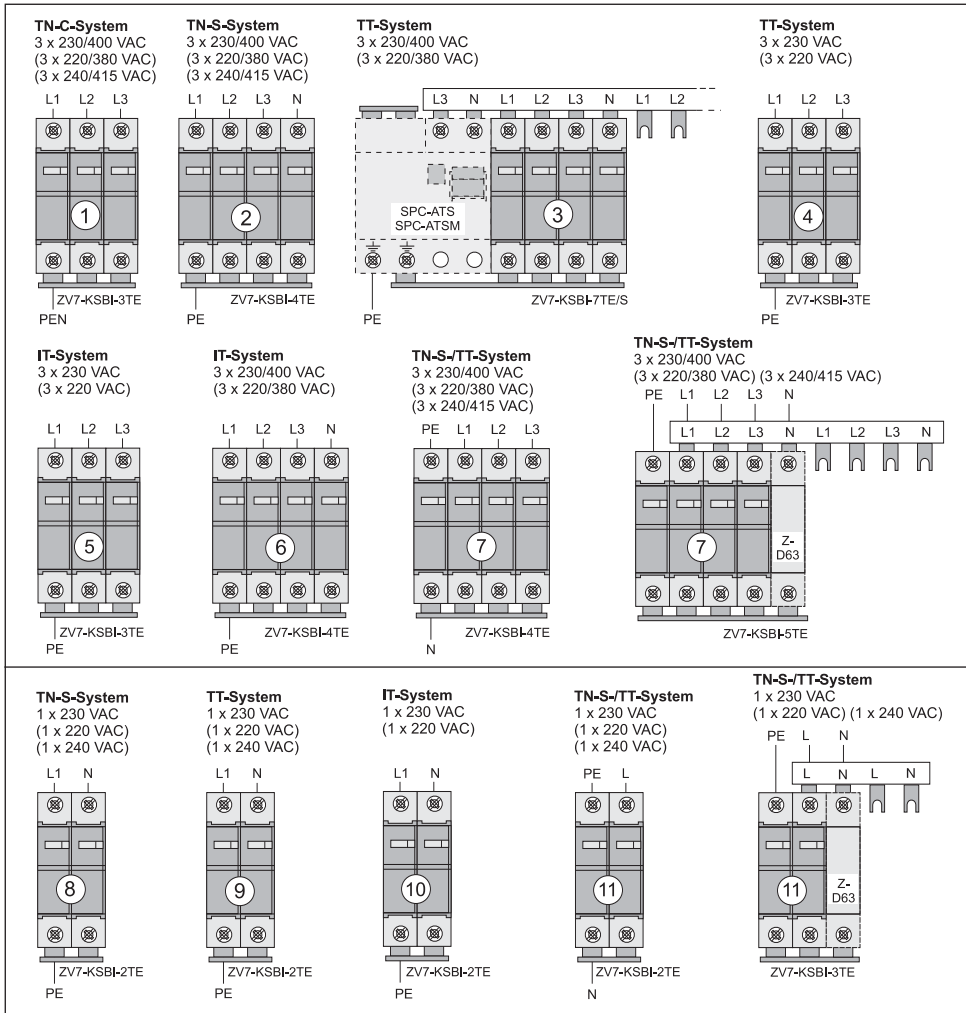

		①	②	③	④	⑤
	IEC 60364-5-534 IEC 60364-5-53 Clause 534	SPC-S-20/280/3	SPC-S-20/280/4	SPC-S-20/460/4	---	SPC-S-20/280/3
A	ÖVE ÖNORM E8001-1	SPC-S-20/335/3	SPC-S-20/335/4	SPC-S-20/460/4	---	SPC-S-20/280/3
D	VDE V 0100-534	SPC-S-20/280/3	SPC-S-20/280/4	SPC-S-20/460/4	---	SPC-S-20/280/3
F	UTE C 20-443	SPC-S-20/385/3	SPC-S-20/385/4	SPC-S-20/385/4	---	SPC-S-20/280/3
N		SPC-S-20/280/3	SPC-S-20/280/4	---	SPC-S-20/280/3	SPC-S-20/385/3

		⑥	⑦	⑧	⑨	⑩
	IEC 60364-5-534 IEC 60364-5-53 Clause 534	SPC-S-20/460/4	SPC-S-3+1 (-SET)	SPC-S-20/280/2	SPC-S-20/460/2	SPC-S-20/460/2
A	ÖVE ÖNORM E8001-1	SPC-S-20/460/4	SPC-S-3+1 (-SET)	SPC-S-20/335/2	SPC-S-20/460/2	SPC-S-20/460/2
D	VDE V 0100-534	SPC-S-20/460/4	SPC-S-3+1 (-SET)	SPC-S-20/280/2	SPC-S-20/460/2	SPC-S-20/460/2
F	UTE C 20-443	SPC-S-20/460/4	---	SPC-S-20/385/2	SPC-S-20/385/2	SPC-S-20/460/2
N		---	---	---	---	---

		⑪	⑫	⑬	⑭
	IEC 60364-5-534 IEC 60364-5-53 Clause 534	SPC-S-1+1	---	---	SPC-S-20/460/1
A	ÖVE ÖNORM E8001-1	SPC-S-1+1	---	---	SPC-S-20/460/1
D	VDE V 0100-534	SPC-S-1+1	---	---	SPC-S-20/460/1
F	UTE C 20-443	---	SPC-S-20/280/1	SPC-S-20/280/3	---
N		---	---	---	---

		IEC 61024-1 IEC 61312-1
		IEC 60364-5-534 IEC 60364-5-53 Clause 534 VDE V 0100-534 ÖVE/ÖNORM E8001-1 UTE C 15-443
		VDE 0100 - 410 VDE 0100 - 430 ÖVE-EN1 Teil 3
		IEC 61643-1 EN 61643-1

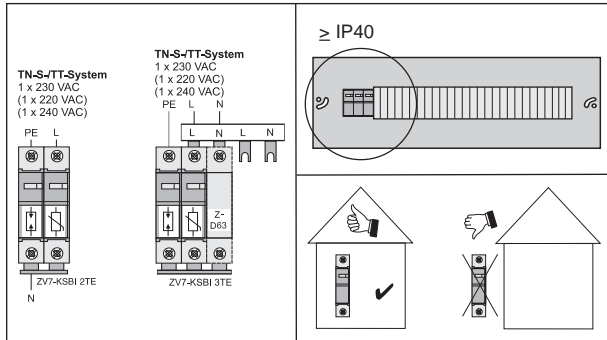
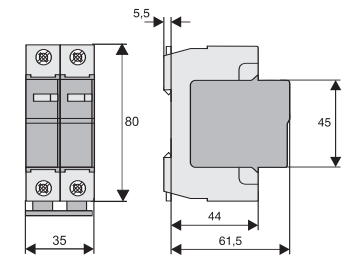
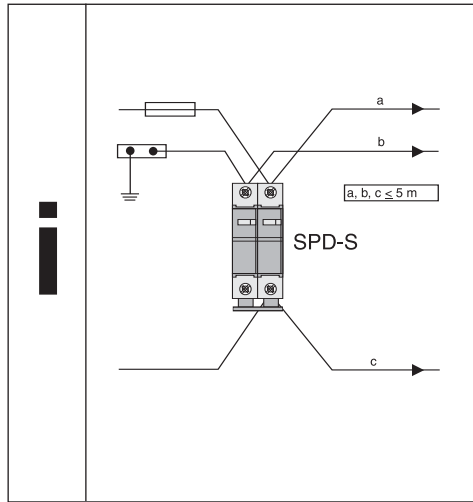

	SPD-S-L/N	SPD-S-N/PE
$U_T$ (IEC 61643-1)	400V	260V
	$I \leq 50 \text{ kA}_{\text{eff}} / \leq 50 \text{ kA}_{\text{r.m.s.}}$	

## SPD-S

Assembly instructions  
Montageanweisung  
Instructions de montage  
Montážni návod  
Montážny návod  
Montagevejledning  
Instrucciones de montaje  
Szerelési utasítás  
Istruzioni di montaggio  
Montasje anvisning  
Montage instructie  
Instruções de montagem  
Instrukcja montażu  
Montageanvisning  
Asennusohjeet  
Montaj talimatı  
Instrucțiuni de montaj  
Инструкция по монтажу  
οδηγία συναρμολόγησης  
安装说明书  
تعليمات التركيب

Danger  
Lebensgefahr  
Danger de mort  
Nebezpečí  
Nebezpečnostvo  
Fare  
Peligro  
Élétveszély  
Pericolo di morte  
Fare  
Levensgevaar  
Perigo  
Niebezpieczeństwo  
Varning  
Vaara  
Hayatı Tehlike  
Pericol  
Οπικότητα  
κίνδυνος θανάτου  
危險  
خطر على الحياة

Powering Business Worldwide

Installation by electricians only  
Montage nur durch Elektrofachkräfte  
Montage uniquement par un électricien  
Montáž pouze osobami s elektrotechnickou kvalifikací  
Montáž iba osobami s elektrotechnickou kvalifikáciou  
Må kun installeres af en aut. e-installatør  
Debe ser instalado por un profesional eléctrico  
Csak szakképzett személy szerelheti  
Montaggio esclusivamente ad opera di personale specializzato  
Må monteres av autorisert installatør Gr.L  
Montage alleen door elektromonteurs  
Deve ser instalado por um profissional  
Montaz tylko przez uprawnionych instalatorów  
Får endast utföras av behörig elektriker  
Asennus vain sähköasiantajan toimesta  
Sadece uzman kişiler monte edebilir  
Instalare numai de catre electricieni  
Монтаж может производить только элекрик  
Εγκατάσταση μόνο από ηλεκτρολόγους  
仅允许合格电气技师进行安装  
التركيب فقط من قبل عمال كهرباء اخصائيين

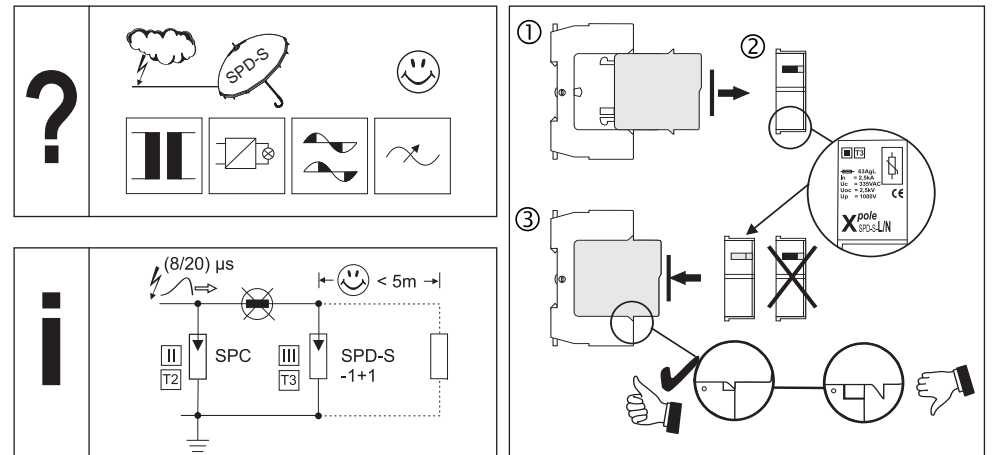
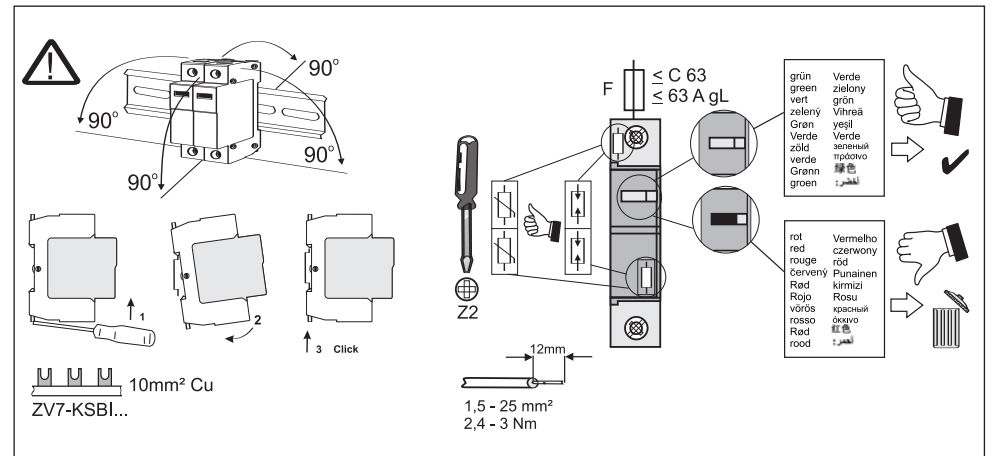

Assembly instructions  
 Montageanweisung  
 Instructions de montage  
 Montážní návod  
 Montážní návod  
 Montagevejledning  
 Instrucciones de montaje  
 Szerelési utasítás  
 Istruzioni di montaggio  
 Montasje anvisning  
 Montage instructie  
 Instruções de montagem  
 Instrukcja montażu  
 Montageanvisning  
 Asennusohjeet  
 Montaj talimatı  
 Instrucțiuni de montaj  
 Инструкция по монтажу  
 οδηγία συναρμολόγησης  
 安装说明书  
 تعليمات التركيب



Danger  
 Lebensgefahr  
 Danger de mort  
 Nebezpečí  
 Nebezpečenstvo  
 Fare  
 Peligro  
 Életveszély  
 Pericolo di morte  
 Fare  
 Levensgevaar  
 Perigo  
 Niebezpieczeństwo  
 Varning  
 Vaara  
 Hayati Tehlike  
 Pericol  
 Опасность  
 κίνδυνος θανάτου  
 危險  
 خطر على الحياة



Installation by electricians only  
 Montage nur durch Elektrofachkräfte  
 Montage uniquement par un électricien  
 Montáž pouze osobami s elektrotechnickou kvalifikací  
 Montáž iba osobami s elektrotechnickou kvalifikáciou  
 Må kun installeres af en aut. el-installatør  
 Debe ser instalado por un profesional eléctrico  
 Csak szakképzett személy szerelheti  
 Montaggio esclusivamente ad opera di personale specializzato  
 Må monteres av autorisert installatør Gr.L  
 Montage alleen door elektromonteurs  
 Deve ser instalado por um profissional  
 Montaz tylko przez uprawnionych instalatorów  
 Får endast utföras av behörig elektriker  
 Asennus vain sähköasentajan toimesta  
 Sadece uzman kisiler monte edebilir  
 Instalare numai de catre electricieni  
 Монтаж может производить только электрик  
 Εγκατάσταση μόνο από ηλεκτρολόγους  
 仅允许合格电气技师进行安装  
 التركيب فقط من قبل عمال كهرباء اختصاصيين

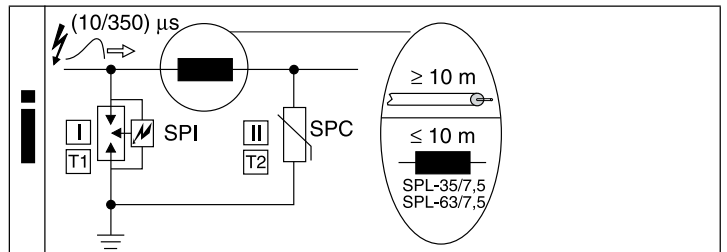
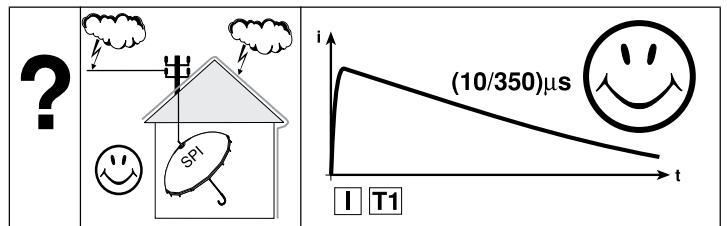
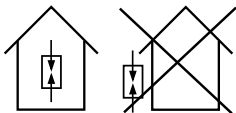
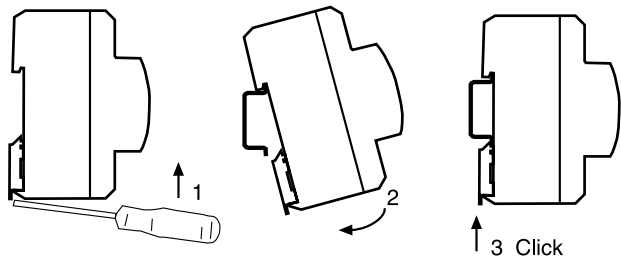
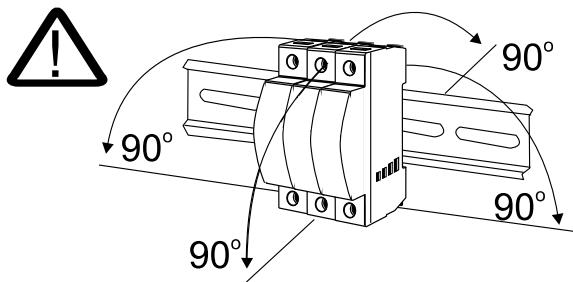

SPI-35/440	14,5 mm ≤ 35 mm <sup>2</sup>	14,5 mm ≤ 25 mm <sup>2</sup>
L, N, ↓	≥ 16 mm <sup>2</sup>	≥ 16 mm <sup>2</sup>
ZV-U ⚠	16 mm <sup>2</sup> CU $\frac{1000}{1000} I > 15,5 \text{ mm}$	

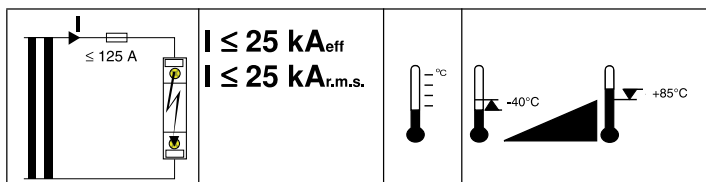
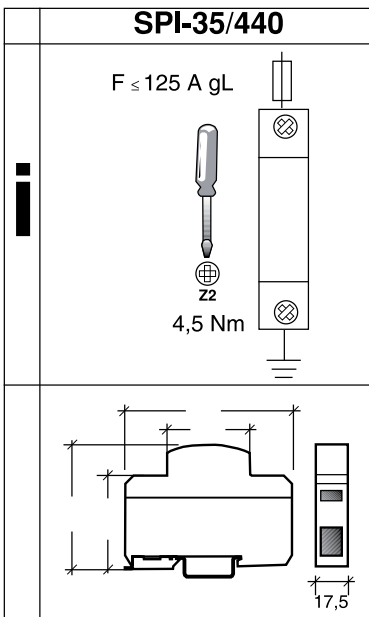

	IEC 61024-1 IEC 61312-1	L, N	VDE 0100-410 VDE 0100-430 ÖVE-EN1 Teil 3
	IEC 60364-5-534 VDE V 0100-534 ÖVE ÖNORM E8001-1 UTE C 15-443		IEC 61643-1 EN 61643-1

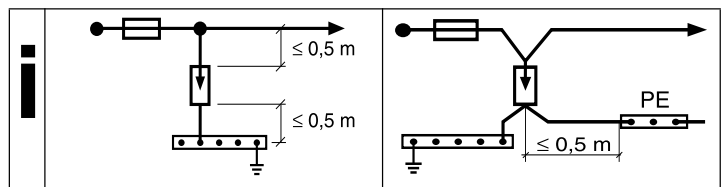

### TN-S

3 x 230/400 V AC  
(3 x 220/380 V AC)

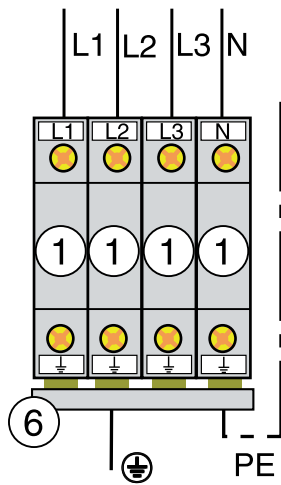

### TN-C

3 x 230/400 V AC  
(3 x 220/380 V AC)

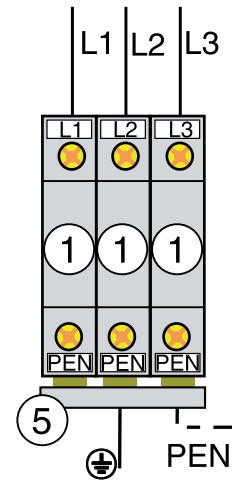

### IT

3 x 230 V AC

3 x 230/400 V AC  
(3 x 220/380 V AC)

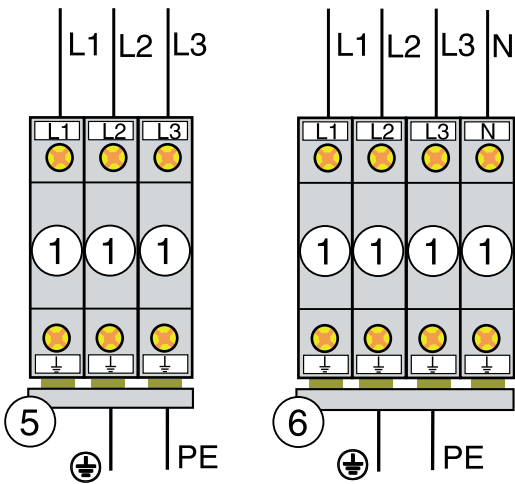

### TN-S / TT

3 x 230/400 V AC  
(3 x 220/380 V AC)

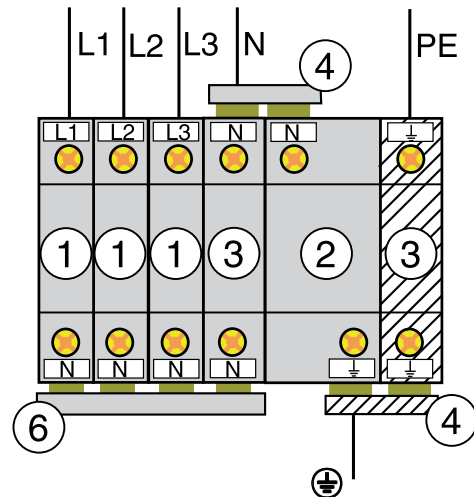

- ① SPI-35/440
- ② SPI-100/NPE  
(SPI-50/NPE / TE 1)
- ③ SPB-D-125
- ④ ZV-U/1-2
- ⑤ ZV-U/1-3
- ⑥ ZV-U/1-4